





- 额定电流最高达 65A
Rated currents up to 65A
- 三相带中线滤波器
There phase and neutral line filter for four wire filtering task
- 适合于星形和三角形的电源网络
Equally suitable for star and delta power networks
- 采用高品质端子台和铝制外壳, 具有高安全、防腐、防护性
- High performance on corrosion protection, safety for used good quality of terminal block and Aluminum Case
- 安规认证: 
Approval: 

特点 Features

- 高衰减性能三相四线滤波器
High performance with high attenuation three phase four lines filter

应用 Application

- 工业设备、其它需四线的电源设备
Industrial equipment and other general purpose power equipments which use four lines White goods, single phase industrial equipments, power supply systems and controls

技术参数 Technical Data

额定电压 Rated Voltage	380/440VAC
工作频率 Operation Frequency	50/60Hz
额定电流 Rated Current	6-65A
耐压测试 Hi-pot Test	1750VDC, 2 sec (线对线 Line to Line) 2650VDC 2sec (线对地 Line to Ground)
气候类别 Climate Category	25/85/21 (-25°C to +85°C)
设计参考标准 Design corresponding to	UL 1283, CSA 22.2 No. 8 1986, IEC/EN 60939

电路原理图 Electrical Schematic

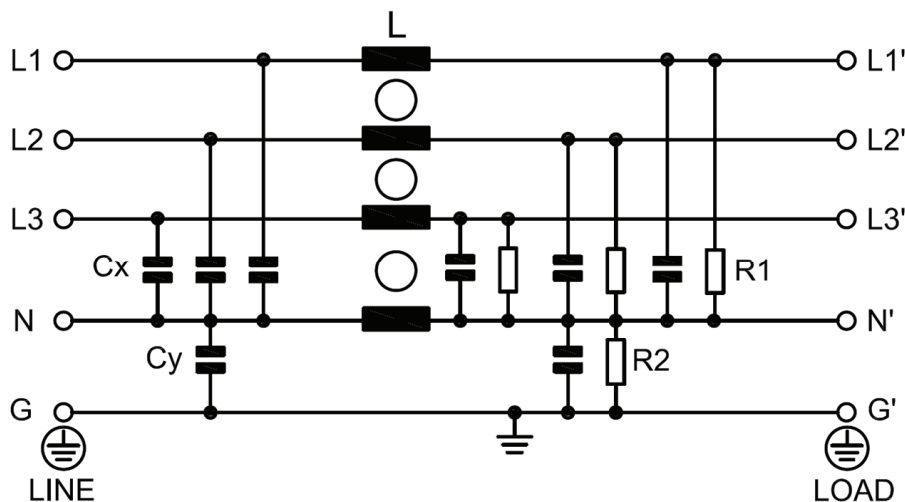



Fig 1

选型表 Type Selection Table

型号 Model	额定电流(A) Rated Current	泄漏电流(≤mA) Leakage Current	电路图 Circuit Diagram	外形尺寸 Dim. Fig.	出线端子方式 Terminal Block	Output Connection
DF401-10A-01T	10	5	Fig 1	Fig 1		T
DF401-20A-01T	30	5	Fig 1	Fig 1		T
DF401-25A-01T	25	5	Fig 1	Fig 1		T
DF401-30A-01T	30	5	Fig 1	Fig 1		T
DF401-40A-01T	40	10	Fig 1	Fig 1		T
DF401-50A-01T	50	10	Fig 1	Fig 1		T
DF401-65A-01T	65	10	Fig 1	Fig 1		T

外形尺寸 Outline Dimensions(mm)

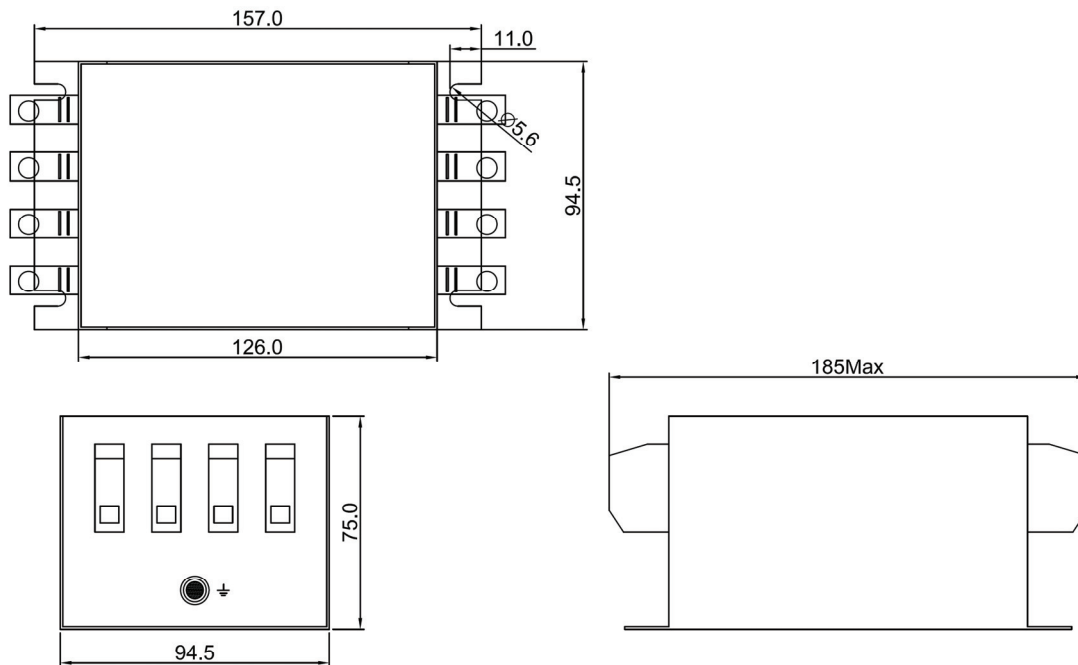
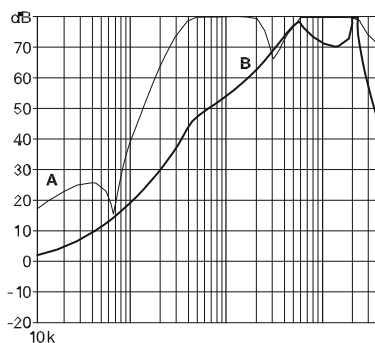

Fig. 1

插入损耗 Insertion Loss in dB

(50Ω/50Ω 环境下插入损耗 Insertion Loss in dB measured in a 50Ω/50Ω system, as IEC/CISPR No. 17)

A=Differential mode (差模) B=Common Mode(共模)



10A types

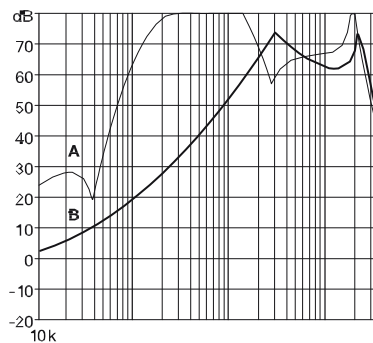

20 to 65A types